

Technical data sheet

Pipe sleeve with 6 fastening straps

Item number: 7202209

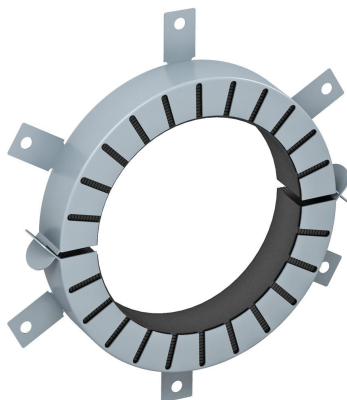

Pipe sleeve for combustible pipes.

If there is a fire, fire protection inserts inside the sheet steel housing expand, exerting a very great pressure onto the burning thermoplastic pipes. For interior application. Fastening with anchors or M8 threaded rods.



Intumescent material

Master data

Item number	7202209
Type	TCX-140
Description 1	Pipe sleeve
Description 2	for combustible pipes
Manufacturer	OBO
Dimension	Ø140mm
Colour	Grey
Material	Intumescent material
Smallest sales unit	1
Unit of quantity	Piece
Weight	106 kg
Weight unit	kg/100 pc.

Dimensions

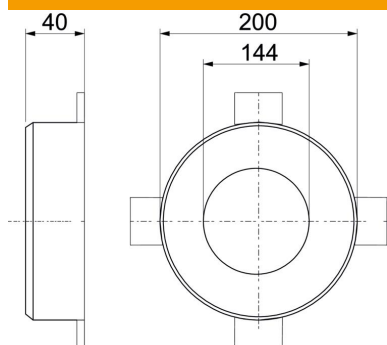

Length	200 mm
Width	200 mm
Height	40 mm
Dimension d	144 mm
Dimension d min.	200 mm
Dimension h	40 mm

Technical data sheet

Pipe sleeve with 6 fastening straps

Item number: 7202209



Technical data

Shape	Round
For pipe diameter, max.	142 mm
For pipe diameter, min.	140 mm
Collar lock	Connector
With fastening material	no
Accessories required	yes