

Technical data sheet

Cover for 90° bend A4

Item number: 6226074



Cover with turn buckles for covering 90° cable ladder bends with welded rungs.



A4 Stainless steel

2B Bright, treated

Master data

Item number	6226074
Type	LBD 90 400 R3 A4
Description 1	90° bend cover
Description 2	with turn buckle
Manufacturer	OBO
Dimension	B400
Material	Stainless steel
Surface	Bright, treated
Surface standard	
Smallest sales unit	1
Unit of quantity	Piece
Weight	350 kg
Weight unit	kg/100 pc.

Technical data sheet

Cover for 90° bend A4

Item number: 6226074



Dimensions

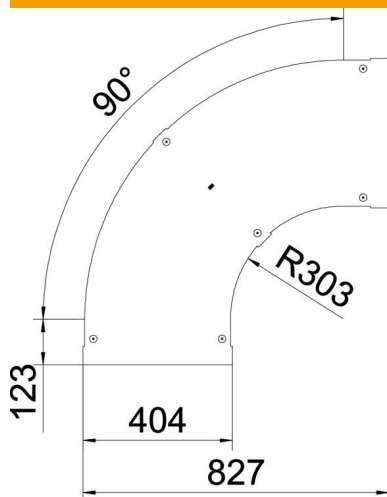

Width	400 mm
Plate thickness	1 mm
Dimension B	400 mm

Technical data

Bend (angle)	90°
Fastening type	Sash lock
Maintain electrical functions	no
Suitable for mesh cable tray	no
Suitable for cable ladder	yes
Suitable for cable tray	no
Change of direction	Horizontal
Rustproof steel, pickled	no
Hinged	no