

Technical data sheet

Locknut, PG thread

Item number: 2043076



Locknut DIN 46320, with PG thread DIN 40430.

Note: Only tighten polystyrene cable glands lightly due to the risk of stress crack formation.



PS Polystyrene

Master data

Item number	2043076
Description 1	Locknut
Manufacturer	OBO
Dimension	PG7
Colour	Light grey; RAL 7035
Material	Polystyrene
Smallest sales unit	100
Unit of quantity	Piece
Weight	0.099 kg
Weight unit	kg/100 pc.
CO Footprint (GWP) Cradle-to-Gate	0,0035 kg COe / 1 Piece

Technical data sheet

Locknut, PG thread

Item number: 2043076



Dimensions



Dimension E	21 mm
Dimension L	5 mm

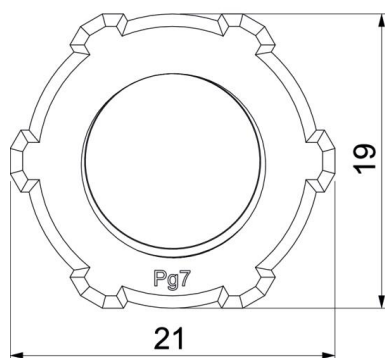

Technical data

Thread	Pg_7
Thread type	PG
Nominal thread size metric/PG	7
Fibre-glass reinforced	no
Halogen-free	yes
Impact-resistant	yes
WAF	19